

PRE-AMPLIFIER, LOW LEVEL & LOW NOISE

■ FEATURES

*High total Power Dissipation. (450mW)

*Excellent h_{FE} linearity.

*Complementary to MMBT9015

*ESD Rating – Human Body Model: >4000 V
– Machine Model: >400 V

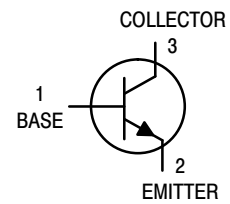

■ ORDERING INFORMATION

Device	Package	Shipping [†]
MMBT9014	SOT-23 (Pb-Free)	3000 / Tape & Reel

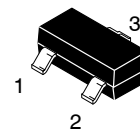

SOT-23

[†]For information on tape and reel specifications, including part orientation and tape sizes, please refer to our Tape and Reel Packaging Specifications Brochure, BRD8011/D.

■ ABSOLUTE MAXIMUM RATINGS ($T_A=25^\circ\text{C}$, unless otherwise specified)

PARAMETER	SYMBOL	RATINGS	UNIT
Collector-Emitter Voltage	V_{CEO}	50	V
Collector-Base Voltage	V_{CBO}	50	V
Emitter Base Voltage	V_{EBO}	5	V
Collector Current	I_C	100	mA
Collector dissipation	P_C	225	mW
Junction Temperature	T_J	150	$^\circ\text{C}$
Storage Temperature	T_{STG}	-55 ~ +150	$^\circ\text{C}$

Note: Absolute maximum ratings are those values beyond which the device could be permanently damaged.

Absolute maximum ratings are stress ratings only and functional device operation is not implied.

■ ELECTRICAL CHARACTERISTICS ($T_A=25^\circ\text{C}$, unless otherwise specified)

PARAMETER	SYMBOL	TEST CONDITIONS	MIN	TYP	MAX	UNIT
Collector-Emitter Voltage	V_{CBO}	$I_C=50 \mu\text{A}, I_E=0$	60			V
Collector-Base Voltage	V_{CEO}	$I_C=1\text{mA}, I_B=0$	50			V
Emitter Base Voltage	V_{EBO}	$I_E=100\mu\text{A}, I_C=0$	5			V
Collector cutoff current	I_{CBO}	$V_{CB}=55\text{V}, I_E=0$			100	nA
Emitter Cutoff Current	I_{EBO}	$V_{EB}=5\text{V}, I_C=0$			100	nA
DC Current Gain	h_{FE}	$V_{CE}=5\text{V}, I_C=1\text{mA}$	60	280	1000	
Collector-Emitter Saturation Voltage	$V_{CE SAT}$	$I_C=100\text{mA}, I_B=5\text{mA}$		0.14	0.3	V
Base-Emitter Saturation Voltage	$V_{BE SAT}$	$I_C=100\text{mA}, I_B=5\text{mA}$		0.84	1.0	V
Base-emitter on voltage	$V_{BE ON}$	$V_{CE}=5\text{V}, I_C=2\text{mA}$	0.58	0.63	0.7	V
Current-Gain-Bandwidth Product	f_T	$V_{CE}=5\text{V}, I_C=10\text{mA}$	150	270		MHz
Output Capacitance	C_{OB}	$V_{CB}=10\text{V}, I_E=0, f=1\text{MHz}$		2.2	3.5	pF
Noise Figure	NF	$V_{CE}=5\text{V}, I_C=0.2\text{mA}, f=1\text{KHz}, R_S=2\text{K}\Omega$		0.9	10	dB

■ CLASSIFICATION OF h_{FE}

RANK	A	B	C	D
RANGE	60-150	100-300	200-600	400-1000

■ TYPICAL CHARACTERISTICS

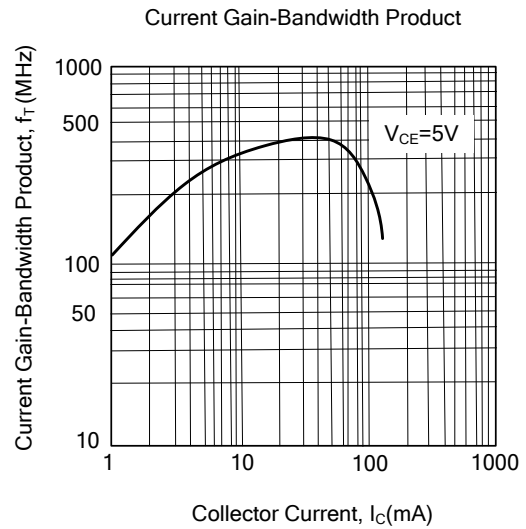
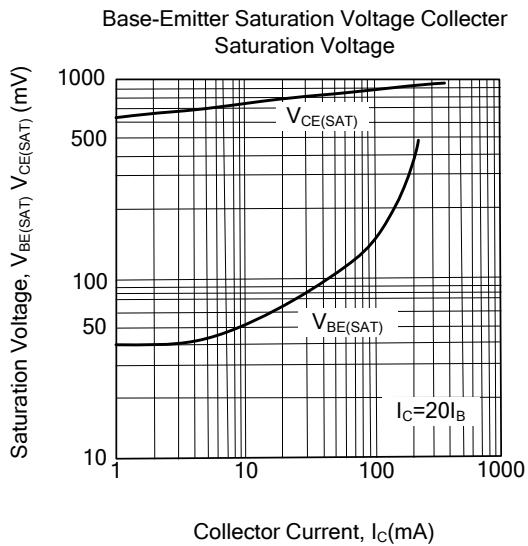
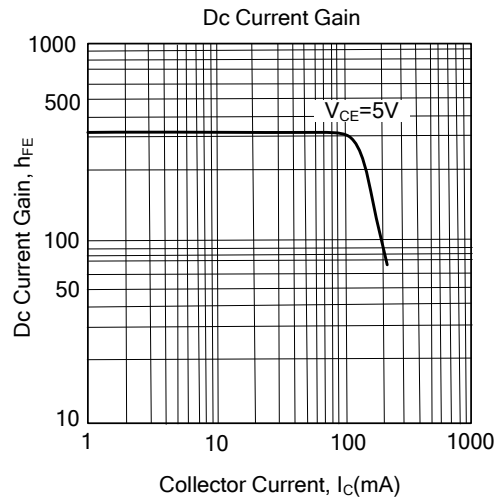
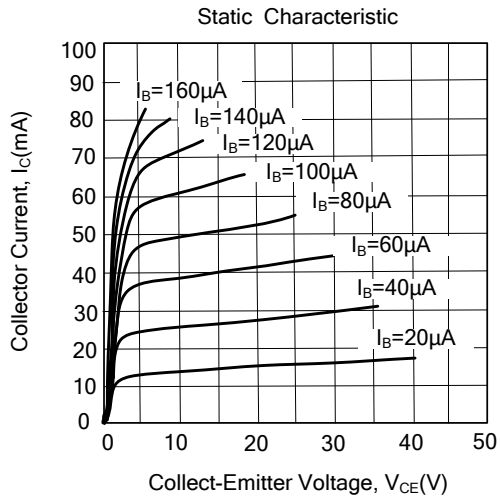

PACKAGE DIMENSIONS

SOT-23

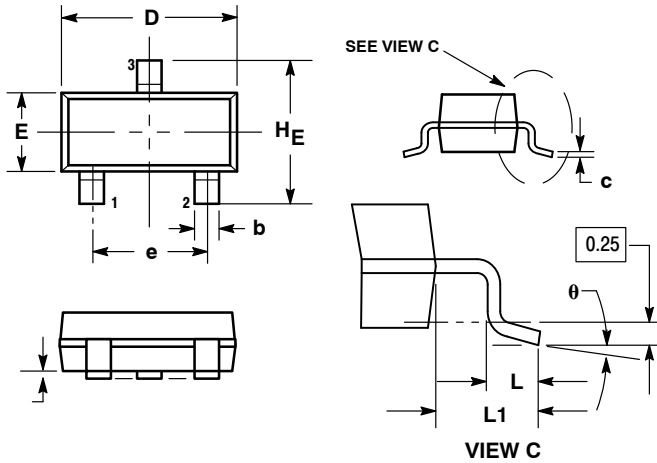

- NOTES:
1. DIMENSIONING AND TOLERANCING PER ANSI Y14.5M, 1982.
 2. CONTROLLING DIMENSION: INCH.
 3. MAXIMUM LEAD THICKNESS INCLUDES LEAD FINISH THICKNESS. MINIMUM LEAD THICKNESS IS THE MINIMUM THICKNESS OF BASE MATERIAL.
 4. DIMENSIONS D AND E DO NOT INCLUDE MOLD FLASH, PROTRUSIONS, OR GATE BURRS.

DIM	MILLIMETERS			INCHES		
	MIN	NOM	MAX	MIN	NOM	MAX
A	0.89	1.00	1.11	0.035	0.040	0.044
A1	0.01	0.06	0.10	0.001	0.002	0.004
b	0.37	0.44	0.50	0.015	0.018	0.020
c	0.09	0.13	0.18	0.003	0.005	0.007
D	2.80	2.90	3.04	0.110	0.114	0.120
E	1.20	1.30	1.40	0.047	0.051	0.055
e	1.78	1.90	2.04	0.070	0.075	0.081
L	0.10	0.20	0.30	0.004	0.008	0.012
L1	0.35	0.54	0.69	0.014	0.021	0.029
HE	2.10	2.40	2.64	0.083	0.094	0.104
θ	0°	---	10°	0°	---	10°

- STYLE 6:
 PIN 1. BASE
 2. EMITTER
 3. COLLECTOR

SOLDERING FOOTPRINT

